

CONNECT

Address: Room 1903, Building A, 95 International Business Center,
JiangNan Road, No. 598, NingBo, China

Mobile Phone: 0086-13429251057

TEL: 0086-574-87475586 88362797

FAX: 0086-574-87474989

E-mail: sales@connectpoultry.com

CONNECT

CONNECT GROUP FOR POULTRY

Exclusive Turnkey Poultry Project Provider

Advanced poultry equipment manufacture

CONTANTS

POULTRY PROCESSING EQUIPMENT	/ 01
RENDERING EQUIPMENT	/ 31
BROILER FARMING EQUIPMENT	/ 51
INCUBATION EQUIPMENT	/ 65
POULTRY FEED PROCESSING EQUIPMENT	/ 81
STEEL FABRICATED HOUSE	/ 82
FREEZING EQUIPMENT	/ 83
CATTLE&SHEEP SLAUGHTERING EQUIPMENT	/ 84

VISION

In the more competition and fast poultry business growing conditions from worldwide, how to keep the leading position in poultry project builders, CONNECT firmly following the four optics:

Clear mission

To consider for customers, maximum do what ever clients request. build high quality project and try best to save investment for clients. With great supporting on technical and project civil work guiding ,and after service.

Constant innovation spirit

Keeping the great competition of products, we take technical Innovation as our company spirit, which consider from animal welfare, healthy, environmental protection and energy saving.

Modestly to learn advanced technology.

Integrity management With heart and assurance service, to communicate and coordinate with customers All for customers to solve any problem with first action. Regular project investigation and engineer re-checking of project after running

Team Work

Keeping the work team in great union ,active. Harmonious. Team work is the core concentric for corporate culture, company and individual create a better future with unity, Cooperation and hard working of all the staff.



To CONNECT customers' needs in providing packing solution for Poultry, Meat industries"

CONNECT is the exclusive turnkey poultry project provider in China to build advanced poultry processing plant, rendering plant, meat and farming industries for poultry and live stock. Our brand - CONNECT is widely used and accepted by the worldwide clients. We supply the turnkey project to meet our customers' complete project need. All products are manufactured according to EU. Standard, and highest world quality standards

CONNECT has five major manufacturing base in China, the agent and distributors are spreading many countries of worldwide. We working together to build excellently projects with high quality equipment and supply best-after sale services to all customers.

CONNECT group introduce a unique houses for raising different types of chicken from broilers, breeders, layers, in a turn-keys project including building and all machines with cages with maximum guarantee time ,with also availability to manage all the projects.

Other packing solution such as Chicken ,egg handling, meat deeply processing systems help you to establish real high quality, turn key project for Farm business.

CONNECT Poultry And Meat World:

A: Poultry Raising

Complete turn key project including building, equipment, electricity, water supply, sewage for complete closed house

For : Broilers-----Raising on ground, on net, in cage with complete equipment.

Breeder-----Pullets and Breeder raising equipment

Layers-----Pullets and layers in Cages with different raising amount in one house, with complete drinking, feeding, egg collection, manure cleaning system.

Grand mother and farther----- With different raising amount.

Incubator-----Single-stage incubator, from thousands eggs to twelve thousands eggs with all automatic control. Multi stage incubator which capacity is ninety thousands eggs.

With automatic tray and chicks processing system, including chicks sorting, ID, counting and packing, egg shell smash, egg washer, ventilation system of hatchery room.

Feed mill----- We cooperate with largest Chinese feed mill manufacture to supply best quality feed mill

Generator-----We cooperate with best Chinese manufacture to supply the back-up power for chicken farm

B. Poultry Processing

Complete turn-key project including building and all processing equipment. Including the below items:

Slaughterhouse---Full automatic and semi-automatic with different capacities, from 500BPH to 12000BPH

Cold room ---- Blast freezer, cold room, freezing tunnel, and Spiral Freezer for slaughterhouse

Rendering plant—slaughterhouse waste including feather, viscera, dead chicken protein recycling system

Waste water-----Slaughterhouse waste water treatment system

Meat processing—Bowl cutter, mixer, tumbler, frying, injection, packing...etc. all type of equipment.

C. Animal Processing

Complete turnkey animal processing line with building and equipment.



CONNECT IS EXCLUSIVE PROVIDE POULTRY TURNKEY PROJECT FROM PROJECT FEASIBILITY STUDY TO WHOLE PROJECT MANAGEMENT.

Including :



Breeder raising



Hatching



Broiler Ground raising system



Cage Raising system



Poultry processing



Feed mill



Fridge



Building



Rendering



Animal Processing

OUR MANUFACTURING EQUIPMENT

The quality of product is not only depends on device, but also depends on the strict process management. With advanced laser cutting machines, and R&D, mould processing, plastic injection system, we manufactured high quality central controlled production strictly follows international management certification.

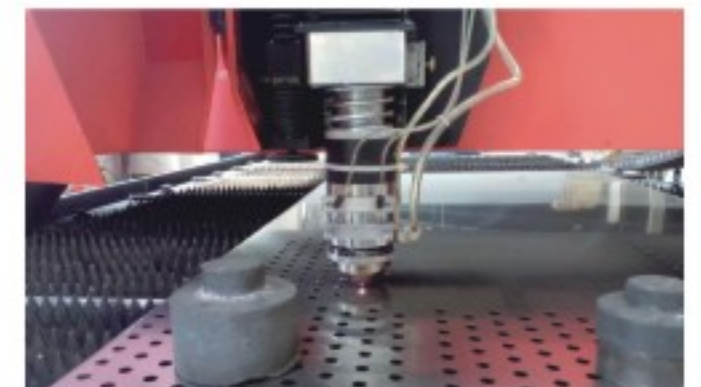



CATTLE SLAUGHTER LINE
牛屠宰线

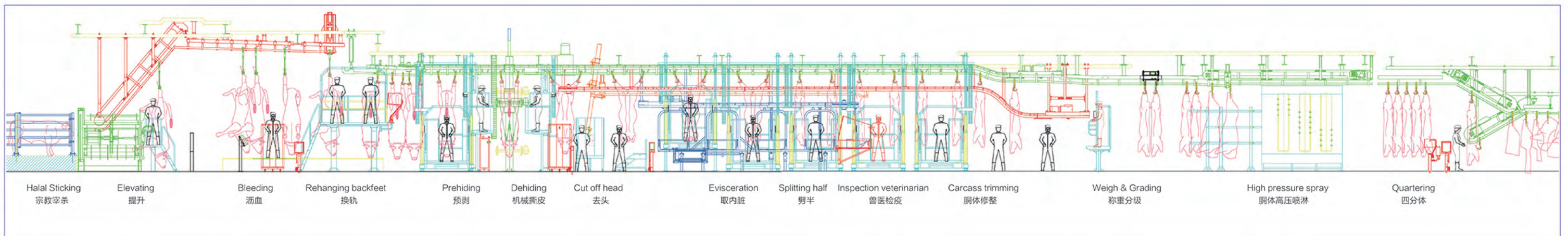

CATTLE SLAUGHTER LINE 牛屠宰线

- STABLE 围栏
- STUNNING & STICKING 击晕和刺杀
- ELEVATING 提升
- REHANGING 换轨
- DEHIDING 撕皮
- EVISCERATION 取内脏
- SPLITTING & TRIMMING 劈半和修整
- WEIGH & SPRAY 称重冲淋
- CHILL & LOGISTICS 预冷&物流
- BONING & CUTTING 剔骨分割
- PACKAGING 包装
- BY PRODUCT PROCESS 副产品加工
- CONVEYOR SYSTEM 输送系统
- SLAUGHTER TOOLS 屠宰工具
- HYGIENE & SANITARY FACILITIES 卫生设施



CATTLE

• STABLE 围栏

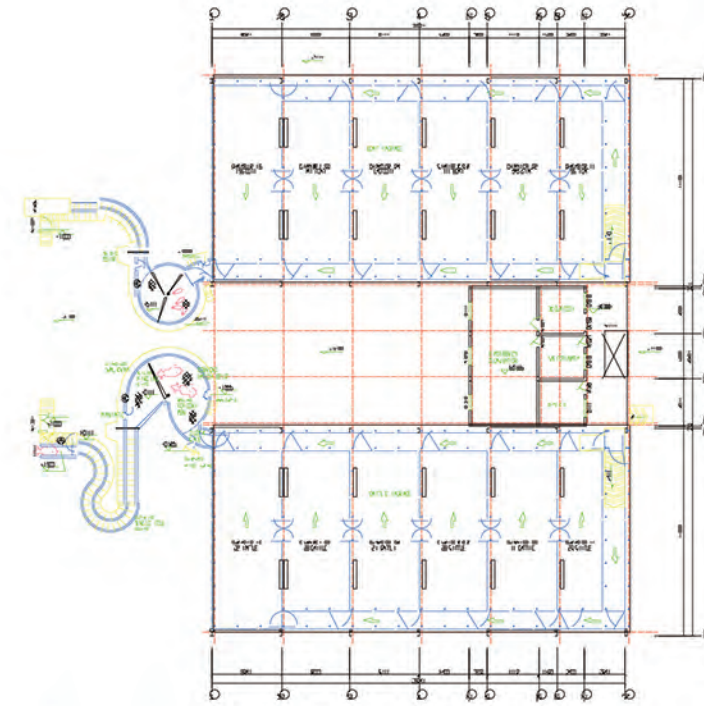

▲ Livestock unloading system from Dr. Temple Grandin



▲ Livestock runway ramp 牲畜斜坡通道

▶ Lairage system for bull 公牛待宰围栏



◀ High quality bolted connecting lairage system for big animal 高质量螺栓连接牛待宰围栏



• STUNNING
击晕



Cattle stunning box pneumatic
牛气动击晕箱



Highlights/特点

- High capacity, up to 60 ph and 100 ph
- Suitable for pneumatic bolt stunner or stunner with cartridge
- Less stress, animal welfare
- Stainless steel or hot galvanized

- 高产量，两个机型，60头和100头每时
- 适用于气动击晕枪或子弹型手持枪
- 低应激，符合动物福利
- 不锈钢或热镀锌材质



Stainless steel / 不锈钢



Hot galvanized / 热镀锌

Halal Ritual killing box – rotating type
宗教式旋转宰杀箱



多型号供选择 Multi-type to choose

Highlights/特点

- Designed fully suitable for ritual sticking
- Suitable for Jewish Kosher (180° turn) and Muslim Halal (90° turn) slaughtering
- Suitable for traditional stunning too
- Capacity up to 45 ph (ritual) and 60 ph (traditional)
- Hydraulic or pneumatic drive, low maintenance
- Stainless steel or hot galvanized

- 设计完全符合宗教式宰杀要求
- 适用于犹太式（180度旋转）和穆斯林式（90度旋转）
- 同样适用于传统击晕式屠宰
- 最高产量45头每时（宗教式）和60头每时（传统式）
- 液压或气动动力，低维护
- 不锈钢或热镀锌材质

• ELEVATING
提升



3 kinds of bleeding elevator
3种毛牛提升装置



High capacity chain elevator
高产能链条提升机



Efficient winch
高效钢丝绳葫芦



Electric chain hoist
电动链条葫芦



BLEEDING LINE 放血线

• REHANGING
换轨



4 kinds of leg rehang device
4种换轨装置

NO.1 ▼ Electric hoist, capacity 40 ph
电动葫芦, 产量40头每小时



NO.2 ▼ Pneumatic swing arm, capacity 60 ph
气动摆臂, 产量60头每小时



NO.3



▲ 3 pneumatic hook up rail, capacity 75 ph
3副气动挂钩轨道系统, 产量75头每小时

NO.4



▲ Electric chain elevator, capacity 120 ph
电动链条式提升机, 产量120头每小时



• DEHIDING
撕皮



Type DH03/DH04 Roller Dehidator
DH03/DH04 型辊筒撕皮机

Highlights/特点

- Capacity up to 60 ph
- Suitable for continuous or discontinuous line
- Joystick for optimum operation
- Optional hook release device
- Optional shock device
- Hydraulic or electric drive
- Stainless steel or hot galvanized
- 最高产量60头每时
- 适用于步进式或连续式屠宰线
- 工业操作手柄使操作性最佳
- 可选的胴体钩支撑系统
- 可选的电刺激系统
- 液压或电机动力
- 不锈钢或热镀锌材质



Type DH05 Roller Dehidator – fixed in MODULE SL TRUCK/HOUSE
DH05 型辊筒撕皮机 – 安装于模块化屠宰车/房



Highlights/特点

- Capacity up to 15 ph
- Hydraulic and electric drive
- Stainless steel
- 最高产量15头每时
- 液压和电机动力
- 不锈钢材质

Type DH06 Roller Dehidator – swing arm
DH06 型辊筒撕皮机 – 摆臂式



- Skin transfer
- 牛皮输送

Type DH10 Dehidator
DH10 型撕皮机

Highlights/特点

- Capacity up to 120 ph
- Suitable for continuous or discontinuous line
- Joystick for optimum operation
- Hook release device
- Optional shock device
- Electric drive
- Totally stainless steel
- 最高产量120头每时
- 适用于步进式或连续式屠宰线
- 工业操作手柄使操作性最佳
- 胴体钩支撑系统
- 可选的电刺激系统
- 电机驱动
- 全不锈钢材质

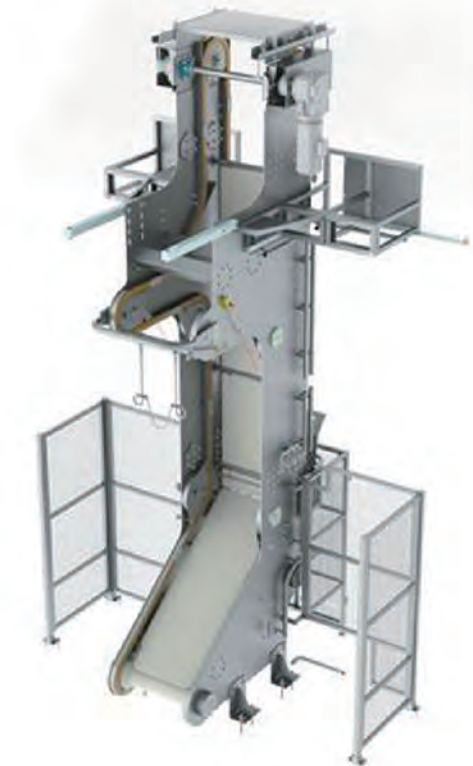

• EVISCERATION
取内脏

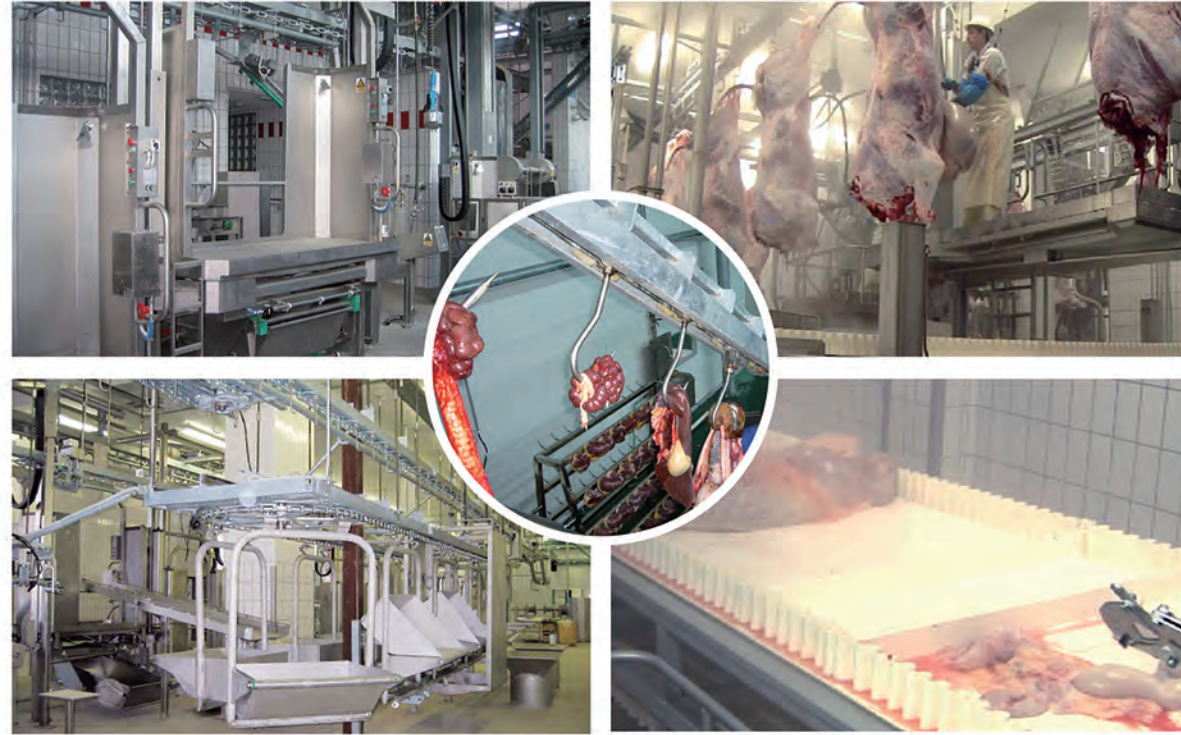

Pneumatic lift eviscerating
取内脏气动升降台



Fixed platform eviscerating
固定式取内脏站台



• SPLITTING & TRIMMING
劈半和修整



Splitting half manually 胴体手工劈半



Spinal cord removal & Vacuum steam sterilizing
取脊髓 & 真空蒸汽消毒



Defatting & Trimming
取油 & 修整

• WEIGHING & SPRAYING
称重和冲淋



Weighing manually/automatically
手动/自动称重



High pressure spray
高压冲淋



Fully automatic High pressure spray system on upper, middle & bottom
全自动高压冲淋系统, 上中下三段

• CHILL & LOGISTICS
预冷&物流



Fast freezing tunnel
快速冷却输送机



Chiller manual rail
预冷手推线轨道



Chiller auto conveyor with optional software
预冷自动线轨道, 可选软件控制



Carcass receiving system
with rotating element
胴体接收系统, 含胴体旋转单元

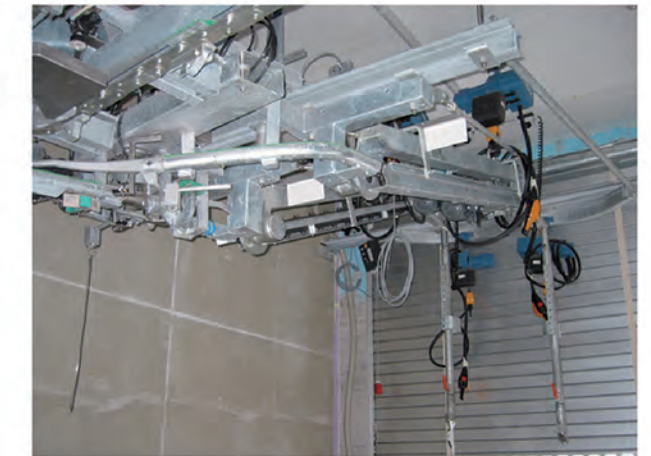

Carcass dispatch system with empty hook
receiving element
胴体发货系统, 含空钩接收单元



Telescopic loading arm with elevator for carcass dispatch
胴体发货汽车接轨器, 含提升机





SHEEP SLAUGHTER LINE
羊屠宰线

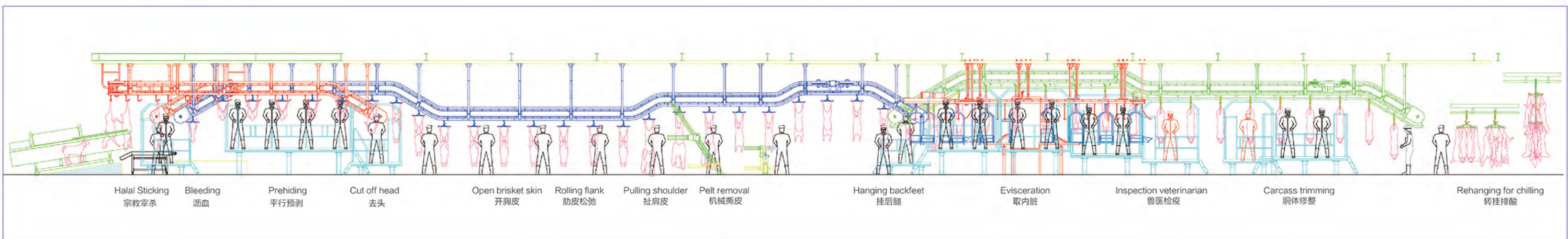

SHEEP SLAUGHTER LINE 羊屠宰线

- STABLE 围栏
- STUNNING & STICKING 击晕和刺杀
- DEHIDING 撕皮
- BONING & CUTTING 剔骨分割
- PACKAGING 包装
- BY PRODUCT PROCESS 副产品加工
- CONVEYOR SYSTEM 输送系统
- SLAUGHTER TOOLS 屠宰工具
- HYGIENE & SANITARY FACILITIES 卫生设施



SHEEP

• STABLE 围栏



High quality bolted connecting lairage system for small animal
高质量螺栓连接羊待宰围栏



• STUNNING & STICKING 击晕和刺杀

V RESTRAINER V型限位器

Highlights/特点

- High capacity, up to 600 ph
- Suitable for electric stunning or halal sticking
- Less stress, animal welfare
- Stainless steel and food grade belt
- 高产量, 600头每时
- 适用于电击晕或穆斯林宰杀
- 低应激, 符合动物福利
- 不锈钢材质, 食品级输送带



• DEHIDING
撕皮



SD01/SD01R/SD04/SD06/SD08 Roller Dehider
SD01/SD01R/SD04/SD06/SD08 型辊筒撕皮机



Highlights/特点

- Capacity from 100 ph up to 600 ph
- Suitable for auto line and manual rail
- Brisket skin prehiding free
- Automatic, very few manpower
- Hydraulic drive, less maintenance
- Stainless steel
- 产量100头至600头每时
- 适用于自动线和手推线
- 胸皮无需预剥
- 自动撕皮, 大大节省人力
- 液压驱动, 少维护
- 不锈钢材质

GD01/GD02 Dehider
GD01/GD02 型撕皮机



Highlights/特点

- Capacity up to 240 ph
- Suitable for manual rail or auto line of speed less than 5m/min
- Suitable for pre-skining till waist
- Hydraulic drive, less maintenance
- Stainless steel
- 产量至240头每时
- 当手推线或自动线速率不大于5米/分钟时适用
- 当羊皮预剥至腰部时适用
- 液压驱动, 少维护
- 不锈钢材质

AD01/AD02 Dehiding Robot
AD01/AD02 型撕皮机器人

Highlights/特点

- Capacity up to 500 ph
- Suitable for auto line
- Automatic, very few manpower
- Hydraulic drive, less maintenance
- Stainless steel
- 产量至500头每时
- 适用于自动线
- 自动撕皮, 大大节省人力
- 液压驱动, 少维护
- 不锈钢材质



AD02 final puller
AD02 最终扯皮机



AD01 shoulder puller/AD01 肩背扯皮机



BONING & CUTTING 剔骨分割

Highlights/特点

- Capacity up to 60 heads per hour
- Boning on the chain or on the manual rail
- Boning of quarter or half carcass
- Fully automatic vacuum packing & heat shrinking system available

- 产量可达60头每小时
- 自动线上剔骨或手推线上剔骨
- 四分区剔骨或二分区剔骨
- 可选的全自动真空包装热缩系统



Quatering & Pre-cutting
四分区 & 预切割

PACKAGING
包装

Vacuum Packaging & Heat Shrinking
真空包装热缩



Automatic carton packing & banding line
自动纸箱包装捆扎线

Belt vacuum packing machine
传输带真空包装机



Beef in hot pot
肥牛包装线



Heat shrinking tunnel
热收缩箱



Vacuum packer
真空包装机

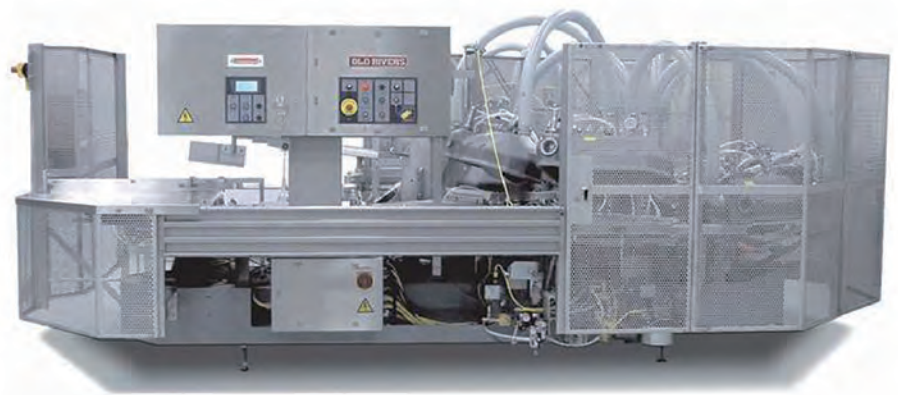

Rotating vacuum packer
旋转真空包装机

• BY PRODUCT PROCESS
副产品加工



■ Rendering plant for bone meal & oil
肉骨粉厂 & 炼油厂



■ Blood collection & Blood powder process line
血收集 & 血粉加工线



■ Semi auto casing line / 半自动肠衣生产线



■ Head & Feet dehairing line with optional hoof remover & head splitter
头蹄脱毛线, 可选去蹄壳机 & 头劈半机



■ Paunch & manifold process line with waste transfer, which is used for fertilizer, elevator, scalding cleaner and defatter
大肚 & 肚加工线, 包括废弃物 (可做肥料) 吹送, 提升机, 淋烫清洗机和除脂机

• CONVEYOR SYSTEM
输送系统

单铰接/双铰接链条系统



Single hinged chain / 单铰接链条 ▲



Double hinged chain / 双铰接链条 ▲

Modular conveyor frame
模块化输送机

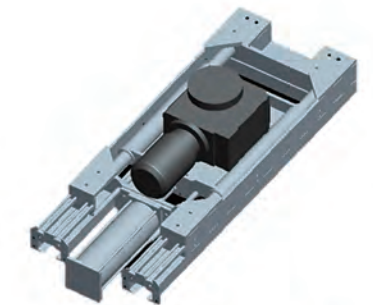
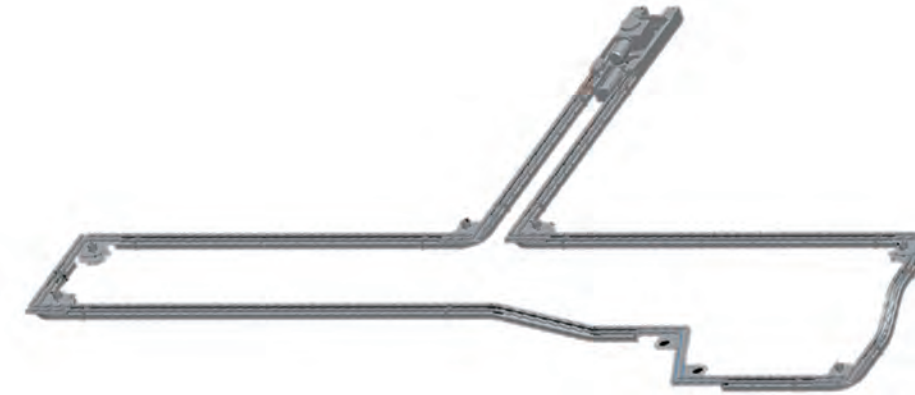

Drive and tension device ▲
驱动涨紧装置

Highlights/特点

- Multi-function due to double hinged chain
- Low noise and lubrication oil consumption
- Longer life due to absence of 'steel to steel contact'
- 双铰接链条使输送机可随意转向和提升
- 低噪音, 减少了润滑油消耗
- 由于避免了'铁与铁'的接触, 使链条寿命更长

Plastic dents / 塑料齿 ▶



Single / Double hinged chain system

Highlights/特点

- Bushing / pivot joints, low wear, easy for lubrication
- Longer life comparing with WEBB chain
- 采用柱销连接, 磨损小, 易润滑
- 与WEBB可拆链条相比, 寿命更长

• IMPORT SLAUGHTERING TOOLS
进口屠宰工具



• HYGIENE & SANITARY FACILITIES
卫生设施

Washing & sterilizing device for pans, hooks and saws
盘, 钩, 锯清洗消毒装置

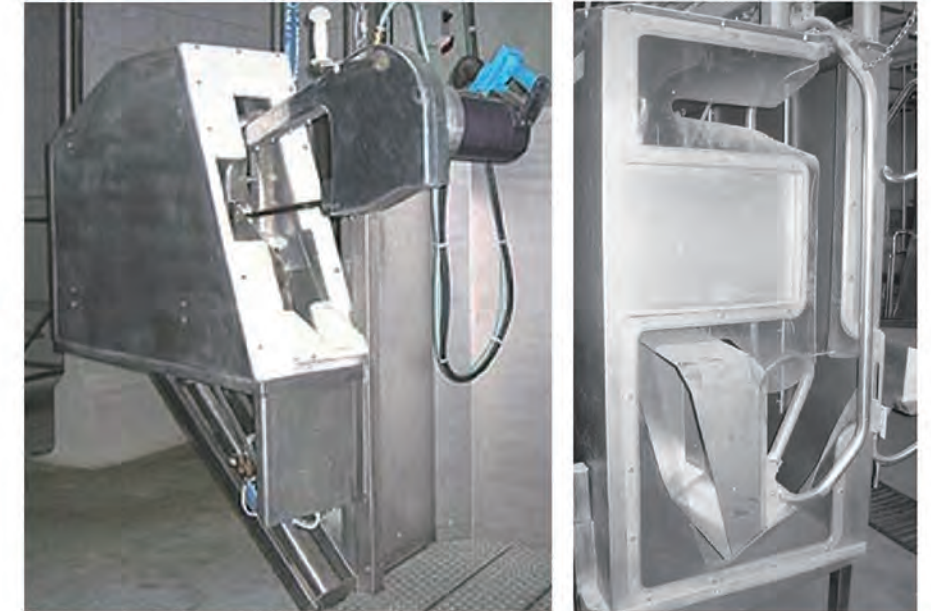

Wide range of cleaning and disinfection device
多种清洗和消毒设备选择



Apron washer
围裙清洗器



Hand wash basin with knife sterilizer
洗手池, 带刀具消毒器



Boot cleaner & Cleanmaster
All-in-one
洗靴机 & 员工清洗消毒站

• PLATFORMS
操作站台



• HOOK STORAGE & RETURN
胴体钩存储&返回



- Designed for empty hook entry, cleaning, storage and distribution
- Designed for various hooks, transport tasks from multi points to multi points
- Fully Automatic control, manpower saving
- 系统设计功能包括空钩接收, 清洗, 储存和分配
- 系统包括各种胴体钩, 空钩可从多点传送至多点
- 全自动控制, 节省人力



• MODULE SLAUGHTER
TRUCK/HOUSE
模块化移动屠宰车/屠宰房



Totally Customized Module Slaughter House Cattle, Sheep, Pig Slaughter Truck
完全由客户定制 - 猪牛羊屠宰车/模块化屠宰房



CONNECT GROUP GLOBAL MARKET DISTRIBUTION NETWORK

